

Data sheet | Item number: 769-609/005-000

1-conductor male connector; Snap-in flange; 4 mm²; Pin spacing 5 mm; 9-pole

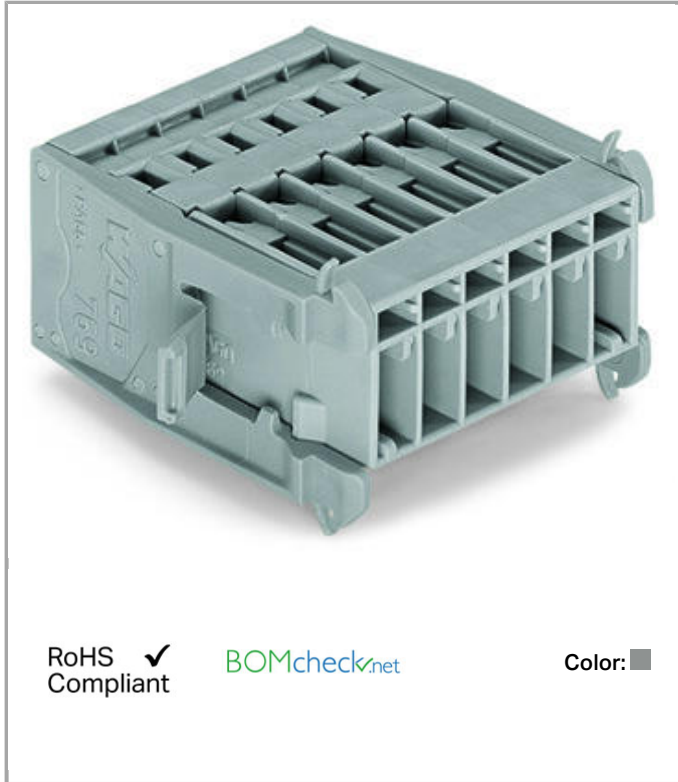

769-609/005-000



RoHS Compliant

[BOMcheck.net](https://www.bomcheck.net)

Color: ■

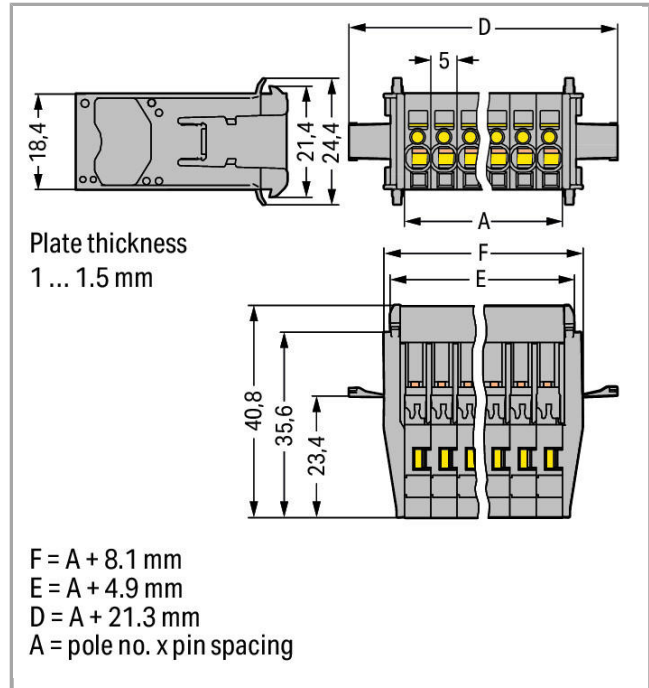

Data

Electrical data

Ratings per IEC/EN 60664-1

Rated voltage (III / 3)	500 V
Rated impulse voltage (III / 3)	6 kV
Rated current	32 A

Connection data

Connection technology	CAGE CLAMP®
Actuation type	Operating tool
Connectable conductor materials	Copper
Nominal cross section	4 mm ²
Solid conductor	0.08 ... 4 mm ² / 28 ... 12 AWG
Fine-stranded conductor	0.08 ... 4 mm ² / 28 ... 12 AWG
Strip length	8 ... 9 mm / 0.31 ... 0.35 inch
No. of poles	9

Total number of connection points	9
Total number of potentials	9
Type of wiring	Front-entry wiring

Geometrical Data

Pin spacing	5 mm / 0.197 inch
Width	66.3 mm / 2.61 inch
Height	24.4 mm / 0.961 inch
Depth	40.8 mm / 1.606 inch

Mechanical data

Mounting type	Snap-in
---------------	---------

Plug connection

Contact type (pluggable connector)	Male connector/plug
Connector connection type	for conductors

Material Data

Color	gray
Insulating material	Polyamide 66 (PA 66)
Fire load	0.577 MJ
Weight	27.803 g

Commercial data

Product Group	18 (X-COM-System)
Country of origin	PL
GTIN	4044918854504
Customs Tariff No.	85366990990



Approvals / Certificates

Country specific Approvals

Logo	Approval	Additional Approval Text	Certificate name
	CCA DEKRA Certification B.V.	IEC 61984	NL-47799
	CCA DEKRA Certification B.V.	EN 61984	2190419.02
	CSA DEKRA Certification B.V.	C22.2 No. 158	1101144

























UL-Approvals

Logo	Approval	Additional Approval Text	Certificate name
	UR Underwriters Laboratories Inc.	UL 1977	E45171
	UR Underwriters Laboratories Inc.	UL 1059	E45172

Compatible products

Marking accessories

	Item no.: 2009-145 Mini-WSB Inline; for Smart Printer; on reel; stretchable 5 - 5.2 mm; plain; snap-on type		2009-145
	Item no.: 2009-145/000-002 Mini-WSB Inline; for Smart Printer; on reel; stretchable 5 - 5.2 mm; plain; snap-on type	/000-002	2009-145
	Item no.: 2009-145/000-005 Mini-WSB Inline; for Smart Printer; on reel; stretchable 5 - 5.2 mm; plain; snap-on type	/000-005	2009-145
	Item no.: 2009-145/000-006 Mini-WSB Inline; for Smart Printer; on reel; stretchable 5 - 5.2 mm; plain; snap-on type	/000-006	2009-145
	Item no.: 2009-145/000-007 Mini-WSB Inline; for Smart Printer; on reel; stretchable 5 - 5.2 mm; plain; snap-on type	/000-007	2009-145
	Item no.: 2009-145/000-012 Mini-WSB Inline; for Smart Printer; on reel; stretchable 5 - 5.2 mm; plain; snap-on type	/000-012	2009-145

	Item no.: 2009-145/000-023 Mini-WSB Inline; for smartPRINTER; on reel; stretchable 5 - 5.2 mm; plain; snap-on type	2009-145 /000-023
	Item no.: 2009-145/000-024 Mini-WSB Inline; for Smart Printer; on reel; stretchable 5 - 5.2 mm; plain; snap-on type	2009-145 /000-024
	Item no.: 210-831 Marking strips; on reel; 2.3 mm wide; plain; Self-adhesive	210-831
	Item no.: 210-832 Marking strips; on reel; 3 mm wide; plain; Self-adhesive	210-832
	Item no.: 210-833 Marking strips; on reel; 6 mm wide; plain; Self-adhesive	210-833
	Item no.: 210-834 Marking strips; on reel; 5 mm wide; plain; Self-adhesive	210-834
	Item no.: 248-501 Miniature WSB Quick marking system; plain; Marker width 5 mm; 10 strips with 10 markers per card	248-501
	Item no.: 248-501/000-002 Mini-WSB marking card; as card; not stretchable; plain; snap-on type	248-501 /000-002
	Item no.: 248-501/000-005 Mini-WSB marking card; as card; not stretchable; plain; snap-on type	248-501 /000-005
	Item no.: 248-501/000-006 Mini-WSB marking card; as card; not stretchable; plain; snap-on type	248-501 /000-006
	Item no.: 248-501/000-007 Mini-WSB marking card; as card; not stretchable; plain; snap-on type	248-501 /000-007
	Item no.: 248-501/000-012 Mini-WSB marking card; as card; not stretchable; plain; snap-on type	248-501 /000-012
	Item no.: 248-501/000-017 Mini-WSB marking card; as card; not stretchable; plain; snap-on type	248-501 /000-017
	Item no.: 248-501/000-023 Mini-WSB marking card; as card; not stretchable; plain; snap-on type	248-501 /000-023
	Item no.: 248-501/000-024 Mini-WSB marking card; as card; not stretchable; plain; snap-on type	248-501 /000-024
Protective Warning Marker		
	Item no.: 280-415 Protective warning marker; with high-voltage symbol, black; for 5 terminal blocks	280-415

Coding

**Item no.: 769-435**

Coding pin; for coding of female plugs; for carrier terminal blocks / male connectors

769-435

Female plug

**Item no.: 769-101**1-conductor female plug; 4 mm²; 1-pole

769-101

**Item no.: 769-101/000-016**1-conductor female plug; 4 mm²; 1-pole

/000-016

769-101

**Item no.: 769-102**1-conductor female plug; 4 mm²; 2-pole

769-102

**Item no.: 769-102/000-036**1-conductor female plug; 4 mm²; 2-pole

/000-036

769-102

**Item no.: 769-102/000-037**1-conductor female plug; 4 mm²; 2-pole

/000-037

769-102

**Item no.: 769-103**1-conductor female plug; 4 mm²; 3-pole

769-103

**Item no.: 769-103/000-036**1-conductor female plug; 4 mm²; 3-pole

/000-036

769-103

**Item no.: 769-103/000-037**1-conductor female plug; 4 mm²; 3-pole

/000-037

769-103

**Item no.: 769-103/000-038**1-conductor female plug; 4 mm²; 3-pole

/000-038

769-103

**Item no.: 769-103/000-039**1-conductor female plug; 4 mm²; 3-pole

/000-039

769-103

**Item no.: 769-104**1-conductor female plug; 4 mm²; 4-pole

769-104

**Item no.: 769-104/000-036**1-conductor female plug; 4 mm²; 4-pole

/000-036

769-104

**Item no.: 769-104/000-037**1-conductor female plug; 4 mm²; 4-pole















/000-037

769-104

**Item no.: 769-104/000-038**1-conductor female plug; 4 mm²; 4-pole

/000-038

769-104

	Item no.: 769-104/000-039 1-conductor female plug; 4 mm ² ; 4-pole	769-104 /000-039
	Item no.: 769-105 1-conductor female plug; 4 mm ² ; 5-pole	769-105
	Item no.: 769-105/000-036 1-conductor female plug; 4 mm ² ; 5-pole	769-105 /000-036
	Item no.: 769-105/000-037 1-conductor female plug; 4 mm ² ; 5-pole	769-105 /000-037
	Item no.: 769-105/000-038 1-conductor female plug; 4 mm ² ; 5-pole	769-105 /000-038
	Item no.: 769-105/000-039 1-conductor female plug; 4 mm ² ; 5-pole	769-105 /000-039
	Item no.: 769-106 1-conductor female plug; 4 mm ² ; 6-pole	769-106
	Item no.: 769-106/000-006 1-conductor female plug; 4 mm ² ; 6-pole	769-106 /000-006
	Item no.: 769-106/000-036 1-conductor female plug; 4 mm ² ; 6-pole	769-106 /000-036
	Item no.: 769-106/000-037 1-conductor female plug; 4 mm ² ; 6-pole	769-106 /000-037
	Item no.: 769-106/000-038 1-conductor female plug; 4 mm ² ; 6-pole	769-106 /000-038
	Item no.: 769-106/000-039 1-conductor female plug; 4 mm ² ; 6-pole	769-106 /000-039
	Item no.: 769-107 1-conductor female plug; 4 mm ² ; 7-pole	769-107
	Item no.: 769-107/000-036 1-conductor female plug; 4 mm ² ; 7-pole	769-107 /000-036
	Item no.: 769-107/000-037 1-conductor female plug; 4 mm ² ; 7-pole	769-107 /000-037
	Item no.: 769-107/000-038 1-conductor female plug; 4 mm ² ; 7-pole	769-107 /000-038

**Item no.: 769-107/000-039**1-conductor female plug; 4 mm²; 7-pole

/000-039

769-107

Item no.: 769-1081-conductor female plug; 4 mm²; 8-pole

769-108

Item no.: 769-108/000-0361-conductor female plug; 4 mm²; 8-pole

/000-036

769-108

Item no.: 769-108/000-0371-conductor female plug; 4 mm²; 8-pole

/000-037

769-108

Item no.: 769-108/000-0381-conductor female plug; 4 mm²; 8-pole

/000-038

769-108

Item no.: 769-108/000-0391-conductor female plug; 4 mm²; 8-pole

/000-039

769-108

Item no.: 769-1091-conductor female plug; 4 mm²; 9-pole

769-109

Item no.: 769-109/000-0361-conductor female plug; 4 mm²; 9-pole

/000-036

769-109

Item no.: 769-109/000-0371-conductor female plug; 4 mm²; 9-pole

/000-037

769-109

Item no.: 769-109/000-0381-conductor female plug; 4 mm²; 9-pole

/000-038

769-109

Item no.: 769-109/000-0391-conductor female plug; 4 mm²; 9-pole

/000-039

769-109

Item no.: 769-109/021-0001-conductor female plug; Locking lever; 4 mm²; 9-pole

/021-000

769-109

Item no.: 769-1212-conductor female connector; 4 mm²; 1-pole

769-121



















Item no.: 769-121/000-0162-conductor female connector; 4 mm²; 1-pole





/000-016

769-121

Item no.: 769-1222-conductor female connector; 4 mm²; 2-pole

769-122

	Item no.: 769-123 2-conductor female connector; 4 mm ² ; 3-pole	769-123
	Item no.: 769-124 2-conductor female connector; 4 mm ² ; 4-pole	769-124
	Item no.: 769-125 2-conductor female connector; 4 mm ² ; 5-pole	769-125
	Item no.: 769-126 2-conductor female connector; 4 mm ² ; 6-pole	769-126
	Item no.: 769-127 2-conductor female connector; 4 mm ² ; 7-pole	769-127
	Item no.: 769-128 2-conductor female connector; 4 mm ² ; 8-pole	769-128
	Item no.: 769-129 2-conductor female connector; 4 mm ² ; 9-pole	769-129
Strain relief plate		
	Item no.: 769-410 Strain relief plate	769-410
	Item no.: 769-413 Strain relief plate	769-413
Insulation stop		
	Item no.: 769-470 Insulation stop; 0.08 - 0.2 mm ² "s" (0.14 mm ² "f-st"); 5 pieces/strip	769-470
	Item no.: 769-471 Insulation stop; 0.25 - 0.5 mm ² ; 5 pieces/strip	769-471
	Item no.: 769-472 Insulation stop; 0.75 - 1 mm ² ; 5 pieces/strip	769-472
ferrule		
	Item no.: 216-101 Ferrule; Sleeve for 0.5 mm ² / AWG 22; uninsulated; electro-tin plated	216-101
	Item no.: 216-102 Ferrule; Sleeve for 0.75 mm ² / AWG 20; uninsulated; electro-tin plated	216-102
	Item no.: 216-103 Ferrule; Sleeve for 1 mm ² / AWG 18; uninsulated; electro-tin plated	216-103
	Item no.: 216-104 Ferrule; Sleeve for 1.5 mm ² / AWG 16; uninsulated; electro-tin plated	216-104
	Item no.: 216-201 Ferrule; Sleeve for 0.5 mm ² / 20 AWG; insulated; electro-tin plated	216-201
	Item no.: 216-202 Ferrule; Sleeve for 0.75 mm ² / 18 AWG; insulated; electro-tin plated	216-202
	Item no.: 216-203 Ferrule; Sleeve for 1 mm ² / AWG 18; insulated; electro-tin plated	216-203

	Item no.: 216-204 Ferrule; Sleeve for 1.5 mm ² / AWG 16; insulated; electro-tin plated	216-204
	Item no.: 216-206 Ferrule; Sleeve for 2.5 mm ² / AWG 14; insulated; electro-tin plated	216-206
tools		
	Item no.: 210-490 Operating tool; for female and male connectors with CAGE CLAMP® connection	210-490
	Item no.: 769-434 Push-button; loose; for female and male connectors with CAGE CLAMP® connection	769-434

Downloads

Documentation

Bid Text

769-609/005-000	doc 25.6 kB	Download
-----------------	----------------	----------

CAD/CAE - Smart Data

CAD data

3D Download 769-609/005-000	URL	Download
-----------------------------	-----	----------

Product family

X-COM

[Learn more about the product family.](#)

[Show all products from the family](#)

Subject to changes.